

**LOCATION:** Grand Ave -- Weldon Ave  
**CITY/STATE:** Oakland, CA

**QC JOB #:** 13350910  
**DATE:** Thu, Apr 23 2015

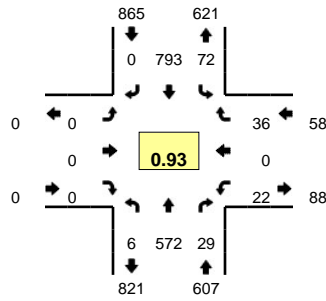

**Peak-Hour: 5:00 PM -- 6:00 PM**  
**Peak 15-Min: 5:45 PM -- 6:00 PM**

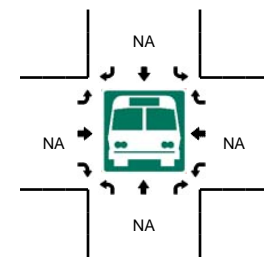
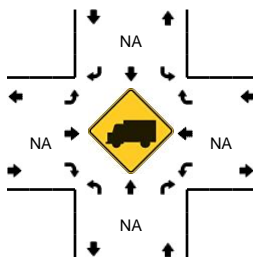
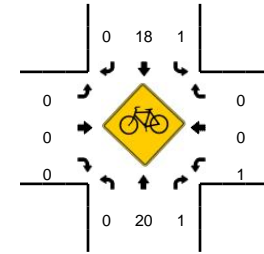
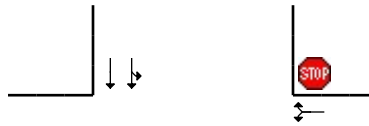
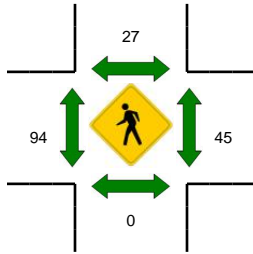
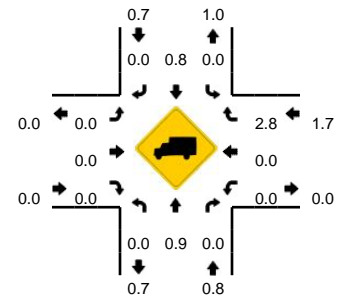

5-Min Count Period Beginning At	Grand Ave (Northbound)				Grand Ave (Southbound)				Weldon Ave (Eastbound)				Weldon Ave (Westbound)				Total	Hourly Totals
	Left	Thru	Right	U	Left	Thru	Right	U	Left	Thru	Right	U	Left	Thru	Right	U		
4:00 PM	0	54	1	0	2	59	0	1	0	0	0	0	1	0	1	0	119	
4:05 PM	0	46	0	0	1	52	0	0	0	0	0	0	0	0	1	0	100	
4:10 PM	0	35	1	1	5	62	0	0	0	0	0	0	4	0	1	0	109	
4:15 PM	0	41	4	1	2	54	0	1	0	0	0	0	0	0	2	0	105	
4:20 PM	0	38	2	1	3	63	0	0	0	0	0	0	1	0	1	0	109	
4:25 PM	0	49	1	2	2	58	0	1	0	0	0	0	1	0	2	0	116	
4:30 PM	0	37	1	1	3	50	0	0	0	0	0	0	0	0	2	0	94	
4:35 PM	0	51	3	0	4	57	0	0	0	0	0	0	2	0	2	0	119	
4:40 PM	0	47	5	1	2	57	0	1	0	0	0	0	1	0	2	0	116	
4:45 PM	0	42	1	0	3	65	0	0	0	0	0	0	1	0	4	0	116	
4:50 PM	0	43	0	0	5	51	0	0	0	0	0	0	1	0	1	0	101	
4:55 PM	0	46	3	0	8	62	0	4	0	0	0	0	0	0	7	0	130	1334
5:00 PM	0	48	3	0	3	60	0	2	0	0	0	0	3	0	3	0	122	1337
5:05 PM	0	43	4	0	2	74	0	0	0	0	0	0	3	0	2	0	128	1365
5:10 PM	0	45	2	0	9	74	0	4	0	0	0	0	0	0	2	0	136	1392
5:15 PM	0	41	3	0	1	58	0	2	0	0	0	0	2	0	4	0	111	1398
5:20 PM	0	38	2	1	4	50	0	0	0	0	0	0	0	0	3	0	98	1387
5:25 PM	0	45	3	0	9	60	0	0	0	0	0	0	2	0	4	0	123	1394
5:30 PM	0	46	2	1	4	62	0	1	0	0	0	0	2	0	3	0	121	1421
5:35 PM	0	55	1	1	0	67	0	1	0	0	0	0	5	0	3	0	133	1435
5:40 PM	0	51	3	1	6	79	0	2	0	0	0	0	1	0	4	0	147	1466
5:45 PM	0	39	1	0	7	64	0	0	0	0	0	0	0	0	4	0	115	1465
5:50 PM	0	57	0	0	6	70	0	0	0	0	0	0	1	0	2	0	136	1500
5:55 PM	0	64	5	2	8	75	0	1	0	0	0	0	3	0	2	0	160	1530
Peak 15-Min Flowrates	Northbound				Southbound				Eastbound				Westbound				Total	
	Left	Thru	Right	U	Left	Thru	Right	U	Left	Thru	Right	U	Left	Thru	Right	U		
All Vehicles	0	640	24	8	84	836	0	4	0	0	0	0	16	0	32	0	1644	
Heavy Trucks	0	4	0	0	0	4	0	0	0	0	0	0	0	0	0	0	8	
Pedestrians		0				20				148				44			212	
Bicycles	0	7	1		1	4	0		0	0	0		0	0	0		13	
Railroad																		
Stopped Buses																		

Comments: