

LOCATION: Grand Ave -- Sunnyslope Ave
CITY/STATE: Oakland, CA

QC JOB #: 13350906
DATE: Tue, Apr 28 2015

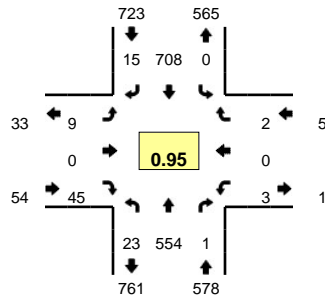

Peak-Hour: 4:40 PM -- 5:40 PM
Peak 15-Min: 5:10 PM -- 5:25 PM

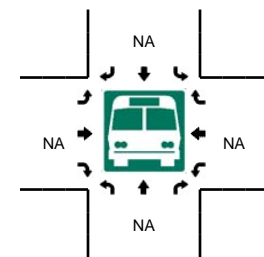
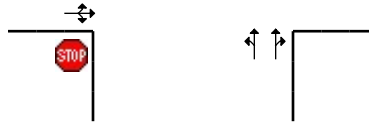
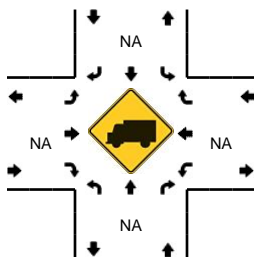
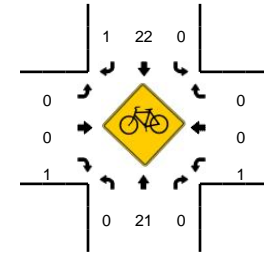
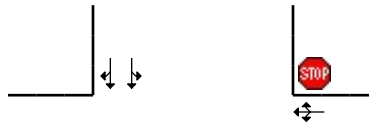
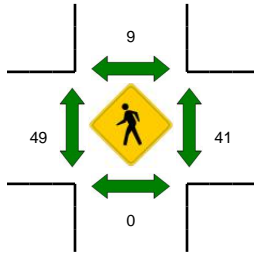
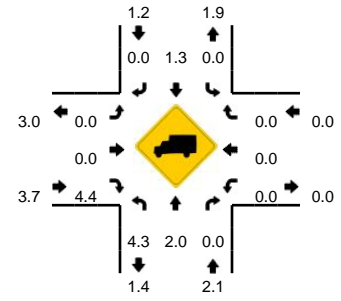

5-Min Count Period Beginning At	Grand Ave (Northbound)				Grand Ave (Southbound)				Sunnyslope Ave (Eastbound)				Sunnyslope Ave (Westbound)				Total	Hourly Totals	
	Left	Thru	Right	U	Left	Thru	Right	U	Left	Thru	Right	U	Left	Thru	Right	U			
4:00 PM	2	48	0	0	0	61	1	0	1	0	3	0	0	0	0	0	116		
4:05 PM	1	32	0	0	0	41	0	1	2	0	2	0	0	0	1	0	80		
4:10 PM	1	36	0	0	0	49	0	0	1	0	2	0	0	0	0	0	89		
4:15 PM	0	36	0	0	0	64	2	0	1	0	3	0	0	0	0	0	106		
4:20 PM	1	30	0	0	0	54	0	0	1	0	5	0	0	0	0	0	91		
4:25 PM	4	38	0	2	0	64	2	0	0	0	1	0	0	0	1	0	112		
4:30 PM	2	40	0	0	0	53	0	0	3	0	1	0	0	0	0	0	99		
4:35 PM	1	37	0	1	0	71	3	0	3	0	1	0	0	0	0	0	117		
4:40 PM	2	44	0	0	0	62	1	0	0	0	5	0	0	0	1	0	115		
4:45 PM	1	60	0	0	0	60	2	0	1	0	3	0	0	0	0	0	127		
4:50 PM	2	34	0	2	0	59	0	0	0	0	3	0	0	0	0	0	100		
4:55 PM	3	51	0	0	0	50	0	0	0	0	1	0	2	0	0	0	107	1259	
5:00 PM	1	48	0	1	0	43	2	0	3	0	8	0	0	0	1	0	107	1250	
5:05 PM	1	38	0	0	0	60	0	0	0	0	8	0	1	0	0	0	108	1278	
5:10 PM	2	44	0	0	0	74	0	0	0	0	1	0	0	0	0	0	121	1310	
5:15 PM	2	52	0	1	0	53	2	0	0	0	4	0	0	0	0	0	114	1318	
5:20 PM	0	51	0	0	0	68	2	0	0	0	2	0	0	0	0	0	123	1350	
5:25 PM	1	44	1	1	0	53	4	0	2	0	5	0	0	0	0	0	111	1349	
5:30 PM	2	43	0	0	0	56	1	0	1	0	4	0	0	0	0	0	107	1357	
5:35 PM	1	45	0	0	0	70	1	0	2	0	1	0	0	0	0	0	120	1360	
5:40 PM	1	40	0	0	0	66	3	0	1	0	2	0	0	0	0	0	113	1358	
5:45 PM	3	50	0	2	0	54	0	0	1	0	3	0	0	0	0	0	113	1344	
5:50 PM	0	44	1	2	0	47	0	0	1	0	2	0	0	0	1	0	98	1342	
5:55 PM	2	46	0	0	0	56	1	0	2	0	2	0	1	0	2	0	112	1347	
Peak 15-Min Flowrates	Northbound				Southbound				Eastbound				Westbound				Total		
	Left	Thru	Right	U	Left	Thru	Right	U	Left	Thru	Right	U	Left	Thru	Right	U			
All Vehicles	16	588	0	4	0	780	16	0	0	0	28	0	0	0	0	0	1432		
Heavy Trucks	0	12	0	0	0	8	0	0	0	0	0	0	0	0	0	0	20		
Pedestrians		0				0				44				40			84		
Bicycles	0	5	0		0	2	0		0	0	1		0	0	0		8		
Railroad																			
Stopped Buses																			

Comments: