

LOCATION: Grand Ave -- Boulevard Way
CITY/STATE: Oakland, CA

QC JOB #: 13350904
DATE: Thu, Apr 23 2015

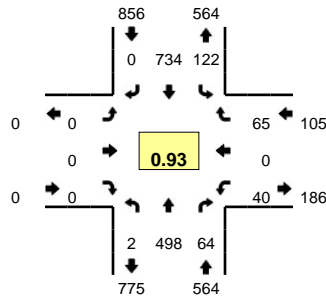

Peak-Hour: 5:00 PM -- 6:00 PM
Peak 15-Min: 5:30 PM -- 5:45 PM

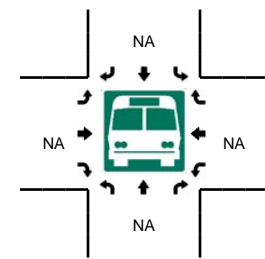
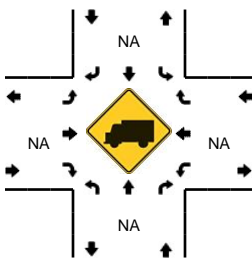
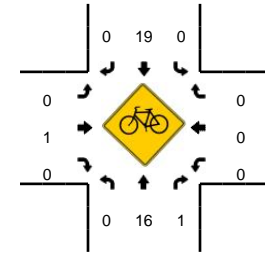
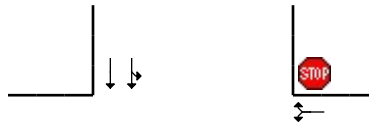
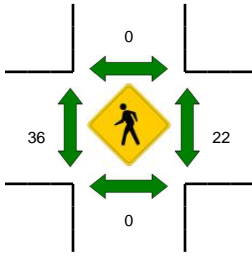
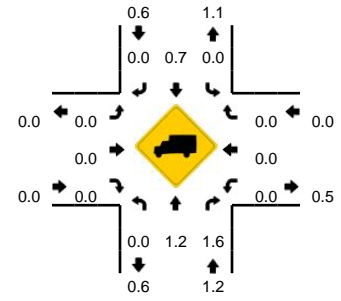

5-Min Count Period Beginning At	Grand Ave (Northbound)				Grand Ave (Southbound)				Boulevard Way (Eastbound)				Boulevard Way (Westbound)				Total	Hourly Totals
	Left	Thru	Right	U	Left	Thru	Right	U	Left	Thru	Right	U	Left	Thru	Right	U		
4:00 PM	0	44	4	0	6	54	0	0	0	0	0	0	2	0	3	0	113	
4:05 PM	0	40	2	0	10	50	0	0	0	0	0	0	1	0	8	0	111	
4:10 PM	0	35	5	0	8	59	0	0	0	0	0	0	0	0	5	0	112	
4:15 PM	0	33	2	0	6	51	0	0	0	0	0	0	1	0	3	0	96	
4:20 PM	0	35	3	0	7	57	0	0	0	0	0	0	3	0	7	0	112	
4:25 PM	0	43	4	0	8	53	0	0	0	0	0	0	3	0	11	0	122	
4:30 PM	0	30	5	0	16	51	0	0	0	0	0	0	1	0	3	0	106	
4:35 PM	0	39	7	0	8	55	0	0	0	0	0	0	3	0	3	0	115	
4:40 PM	0	29	11	0	8	54	0	0	0	0	0	0	3	0	8	0	113	
4:45 PM	0	31	7	0	7	58	0	0	0	0	0	0	3	0	5	0	111	
4:50 PM	0	37	5	0	10	44	0	0	0	0	0	0	3	0	4	0	103	
4:55 PM	0	40	6	0	7	67	0	0	0	0	0	0	5	0	5	0	130	1344
5:00 PM	0	44	7	0	15	54	0	0	0	0	0	0	2	0	4	0	126	1357
5:05 PM	0	49	4	0	13	55	0	0	0	0	0	0	2	0	3	0	126	1372
5:10 PM	0	44	0	1	11	58	0	0	0	0	0	0	6	0	6	0	126	1386
5:15 PM	0	35	5	0	9	58	0	0	0	0	0	0	5	0	6	0	118	1408
5:20 PM	0	32	3	0	8	48	0	0	0	0	0	0	5	0	6	0	102	1398
5:25 PM	0	42	7	0	15	70	0	0	0	0	0	0	2	0	7	0	143	1419
5:30 PM	0	43	5	0	11	66	0	1	0	0	0	0	1	0	7	0	134	1447
5:35 PM	0	42	6	0	7	69	0	0	0	0	0	0	3	0	2	1	130	1462
5:40 PM	0	51	5	0	7	72	0	0	0	0	0	0	4	0	6	0	145	1494
5:45 PM	0	32	10	1	9	55	0	0	0	0	0	0	2	0	4	0	113	1496
5:50 PM	0	40	6	0	8	65	0	0	0	0	0	0	2	0	9	0	130	1523
5:55 PM	0	44	6	0	8	64	0	0	0	0	0	0	5	0	5	0	132	1525
Peak 15-Min Flowrates	Northbound				Southbound				Eastbound				Westbound				Total	
	Left	Thru	Right	U	Left	Thru	Right	U	Left	Thru	Right	U	Left	Thru	Right	U		
All Vehicles	0	544	64	0	100	828	0	4	0	0	0	0	32	0	60	4	1636	
Heavy Trucks	0	4	0	0	0	8	0	0	0	0	0	0	0	0	0	0	12	
Pedestrians		0				0				28				12			40	
Bicycles	0	6	1		0	3	0		0	0	0		0	0	0		10	
Railroad																		
Stopped Buses																		

Comments: