

LOCATION: Grand Ave -- Mandana Blvd
CITY/STATE: Oakland, CA

QC JOB #: 13350913
DATE: Tue, Apr 28 2015

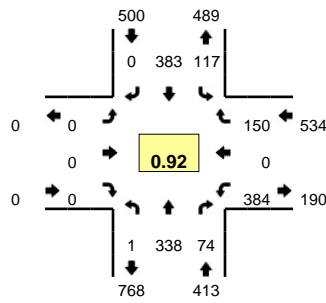

Peak-Hour: 7:55 AM -- 8:55 AM
Peak 15-Min: 8:25 AM -- 8:40 AM

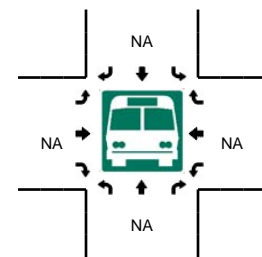
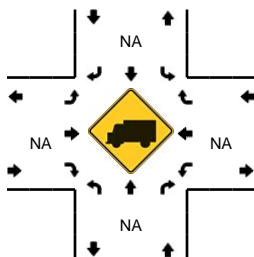
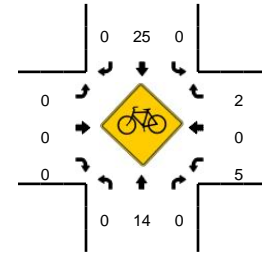
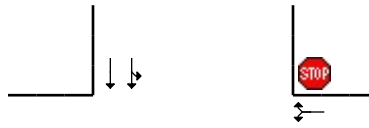
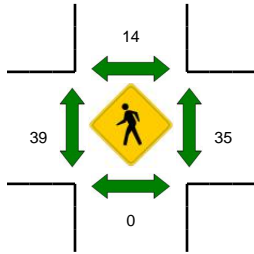
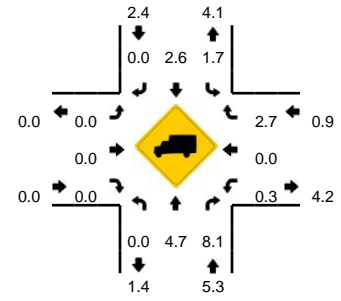

5-Min Count Period Beginning At	Grand Ave (Northbound)				Grand Ave (Southbound)				Mandana Blvd (Eastbound)				Mandana Blvd (Westbound)				Total	Hourly Totals
	Left	Thru	Right	U	Left	Thru	Right	U	Left	Thru	Right	U	Left	Thru	Right	U		
7:00 AM	0	9	4	1	3	11	0	0	0	0	0	0	23	0	6	0	57	
7:05 AM	0	13	3	0	3	9	0	0	0	0	0	0	16	0	6	0	50	
7:10 AM	0	12	3	0	1	11	0	0	0	0	0	0	17	0	6	0	50	
7:15 AM	0	12	3	0	2	9	0	0	0	0	0	0	12	0	6	0	44	
7:20 AM	0	21	5	0	2	12	0	0	0	0	0	0	13	0	6	0	59	
7:25 AM	0	24	1	0	2	22	0	0	0	0	0	0	23	0	4	0	76	
7:30 AM	0	26	2	0	5	14	0	0	0	0	0	0	22	0	6	0	75	
7:35 AM	0	24	5	0	1	29	0	0	0	0	0	0	17	0	9	0	85	
7:40 AM	0	25	3	0	5	26	0	0	0	0	0	0	19	0	5	0	83	
7:45 AM	0	23	6	0	5	22	0	0	0	0	0	0	18	0	5	0	79	
7:50 AM	0	31	5	0	4	22	0	0	0	0	0	0	32	0	11	0	105	
7:55 AM	0	38	3	0	6	31	0	0	0	0	0	0	32	0	8	0	118	881
8:00 AM	0	27	7	0	12	42	0	0	0	0	0	0	26	0	15	0	129	953
8:05 AM	0	37	10	0	8	28	0	0	0	0	0	0	31	0	14	0	128	1031
8:10 AM	0	26	5	0	9	32	0	0	0	0	0	0	35	0	11	0	118	1099
8:15 AM	0	25	4	0	5	26	0	0	0	0	0	0	29	0	19	0	108	1163
8:20 AM	0	20	4	0	6	27	0	0	0	0	0	0	31	0	12	0	100	1204
8:25 AM	0	33	7	0	14	51	0	1	0	0	0	0	27	0	9	0	142	1270
8:30 AM	0	18	11	0	9	23	0	0	0	0	0	0	32	0	17	0	110	1305
8:35 AM	0	32	6	0	18	37	0	0	0	0	0	0	36	0	12	0	141	1361
8:40 AM	0	27	9	1	12	36	0	0	0	0	0	0	33	0	6	0	124	1402
8:45 AM	0	26	5	0	8	27	0	0	0	0	0	0	31	0	13	0	110	1433
8:50 AM	0	29	3	0	9	23	0	0	0	0	0	0	41	0	14	0	119	1447
8:55 AM	0	33	6	0	10	26	0	0	0	0	0	0	24	0	18	0	117	1446
Peak 15-Min Flowrates	Northbound				Southbound				Eastbound				Westbound				Total	
	Left	Thru	Right	U	Left	Thru	Right	U	Left	Thru	Right	U	Left	Thru	Right	U		
All Vehicles	0	332	96	0	164	444	0	4	0	0	0	0	380	0	152	0	1572	
Heavy Trucks	0	20	8		4	20	0		0	0	0		0	0	4		56	
Pedestrians		0				16				32				32			80	
Bicycles	0	5	0		0	5	0		0	0	0		1	0	0		11	
Railroad																		
Stopped Buses																		

Comments: