

LOCATION: Grand Ave -- Sunnyslope Ave
CITY/STATE: Oakland, CA

QC JOB #: 13350905
DATE: Tue, Apr 28 2015

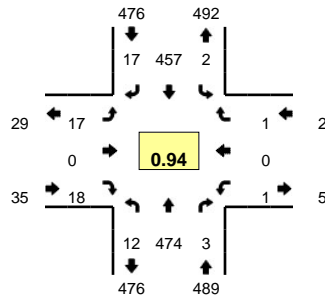

Peak-Hour: 8:00 AM -- 9:00 AM
Peak 15-Min: 8:00 AM -- 8:15 AM

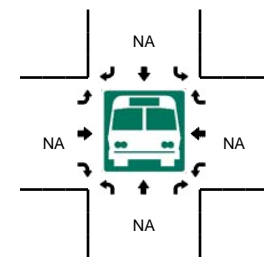
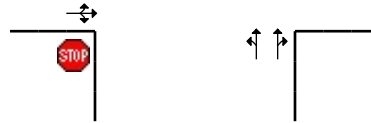
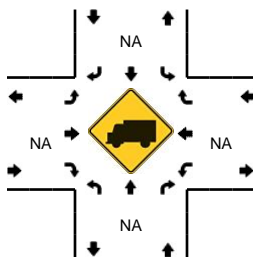
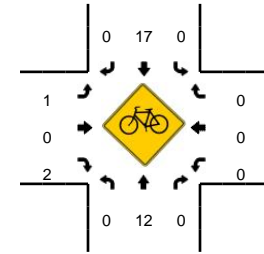
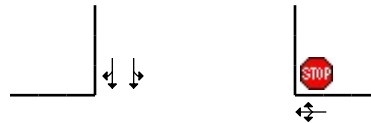
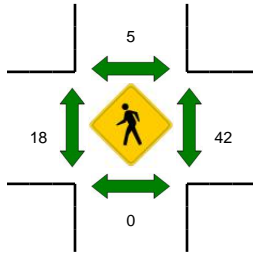
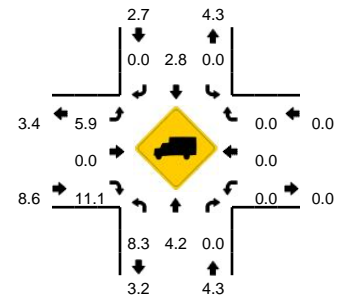

5-Min Count Period Beginning At	Grand Ave (Northbound)				Grand Ave (Southbound)				Sunnyslope Ave (Eastbound)				Sunnyslope Ave (Westbound)				Total	Hourly Totals
	Left	Thru	Right	U	Left	Thru	Right	U	Left	Thru	Right	U	Left	Thru	Right	U		
7:00 AM	0	11	0	0	0	12	0	0	0	0	0	0	0	0	0	0	23	
7:05 AM	0	18	0	0	0	12	0	0	0	0	0	0	0	0	0	0	30	
7:10 AM	1	11	1	0	0	10	0	0	0	0	0	0	0	0	0	0	23	
7:15 AM	0	15	0	0	0	12	0	0	0	0	0	0	0	0	0	0	27	
7:20 AM	0	21	0	0	0	15	0	0	0	0	0	0	0	0	0	0	36	
7:25 AM	0	20	0	0	0	11	0	0	0	0	0	3	0	0	0	0	34	
7:30 AM	0	22	0	0	0	18	0	0	1	0	2	0	0	0	0	0	43	
7:35 AM	0	30	0	0	0	19	1	0	2	0	1	0	0	0	0	0	53	
7:40 AM	0	29	0	0	0	27	0	0	0	0	3	0	0	0	0	0	59	
7:45 AM	0	23	0	0	0	20	1	0	1	0	1	0	0	0	0	0	46	
7:50 AM	0	39	0	0	0	26	1	0	3	0	2	0	0	0	0	0	71	
7:55 AM	3	37	1	0	0	30	1	0	2	0	2	0	0	0	0	0	76	521
8:00 AM	0	48	0	0	1	45	2	0	2	0	1	0	0	0	0	0	99	597
8:05 AM	1	49	1	0	0	35	0	0	2	0	1	0	0	0	0	0	89	656
8:10 AM	0	42	0	0	0	34	1	0	1	0	0	0	0	0	0	0	78	711
8:15 AM	0	48	0	0	0	28	3	0	2	0	0	0	0	0	0	0	81	765
8:20 AM	0	36	0	0	0	37	0	0	1	0	1	0	0	0	0	0	75	804
8:25 AM	3	33	0	0	0	49	2	0	0	0	5	0	0	0	0	0	92	862
8:30 AM	1	44	0	0	0	35	1	0	1	0	1	0	0	0	1	0	84	903
8:35 AM	3	36	0	0	0	48	1	0	1	0	0	0	0	0	0	0	89	939
8:40 AM	1	25	0	0	0	44	0	0	1	0	2	0	1	0	0	0	74	954
8:45 AM	0	38	1	0	0	33	3	0	2	0	3	0	0	0	0	0	80	988
8:50 AM	2	38	1	0	1	33	4	0	0	0	0	0	0	0	0	0	79	996
8:55 AM	1	37	0	0	0	36	0	0	4	0	4	0	0	0	0	0	82	1002
Peak 15-Min Flowrates	Northbound				Southbound				Eastbound				Westbound				Total	
	Left	Thru	Right	U	Left	Thru	Right	U	Left	Thru	Right	U	Left	Thru	Right	U		
All Vehicles	4	556	4	0	4	456	12	0	20	0	8	0	0	0	0	0	1064	
Heavy Trucks	4	32	0	0	0	20	0	0	4	0	4	0	0	0	0	0	64	
Pedestrians		0				4				20				52			76	
Bicycles	0	3	0		0	3	0		0	0	1		0	0	0		7	
Railroad																		
Stopped Buses																		

Comments: